

CARE AND MAINTENANCE

1. Regular washing down of the exterior surface will help prolong the lustre of the painted finish.
2. Painted fountains that become dull due to prolonged exposure to direct sunlight can be restored with an appropriate surface polish.
3. To maintain the exterior of the fountain carefully remove any loose surface deposits with a wet sponge. Use a soft (non abrasive) brush and dilute a solution of mild detergent (eg. PH-neutral liquid hand washing detergent in warm water (DO NOT use solvents) to remove dust, salt and other deposits. Rinse thoroughly with clean fresh water to remove residues. To remove any Tea Staining on Stainless Steel surfaces we recommend Drifter Hull cleaner and stain remover.
4. Do not use any solvents on the surface as this will adversely affect the longevity of the painted finish.
5. Surface scratches and inconsistencies can be touched up using Dulux touch up paint. Most colours can be matched.
6. We recommend the use of anti-seize paste on all external fixing bolts to maintain ease of access over long periods of time.
7. Check the fountain internal connections, water flow and all external access screws and fixing bolts regularly (every 3mths) to ensure they are tight.
8. In high debris areas (parks, children's playgrounds etc) where there may be sand or bark or a lot of leaf litter that may be placed in to the basin, check regularly and remove debris to prevent blocking of the basin or the waste outlet pipe.
9. After any interruption to the water supply, always flush the lines prior to reconnection to the fountain to prevent debris entering the valve.

WARRANTY

All Urban Fountains and Furniture outdoor drinking fountains are covered by a 2 year manufacturers guarantee against faulty materials and workmanship under normal wear and tear conditions.

All fountains are date stamped at the time of despatch.

This warranty will only apply under the following conditions:

- The fountain was installed in accordance with our installation instructions that are supplied with every fountain.
- The fountain was installed by a licensed plumber
- The water lines have been thoroughly flushed prior to connection to the fountain
- The fountain has not been tampered with or repaired in any way without obtaining prior approval from our factory specialists first.
- The fountain has been serviced and maintained as per our supplied instructions.

ATTENTION PLUMBERS

This fountain uses "Push In Fittings".

Failure to release these fittings correctly will result in leakage.

These quick release fittings allow instant connection and disconnection without the use of spanners.

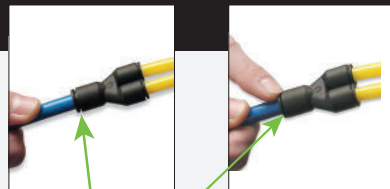

Push outer ring in to release tube from fitting

urban Fountains + Furniture

Drinking Fountains

Models: A280W

urban + Fountains + Furniture

INSTALLATION, OPERATION AND MAINTENANCE INSTRUCTIONS

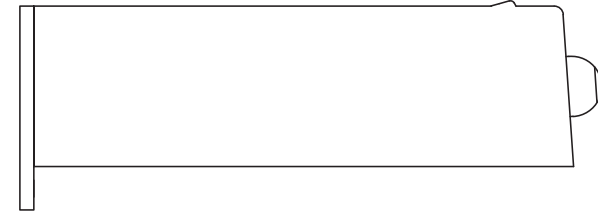

Model: A280W

SPECIFICATIONS

- ▶ 1/2" bsb water inlet (15mm)
- ▶ 40mm waste outlet
- ▶ Maximum Temperature: 40°C
- ▶ Maximum Water Pressure: 500 kpa
- ▶ Complies with WMTS-105 Technical Specification: Appliances - Beverage dispensers and icemakers
- ▶ Complies with AS/NZS 4020 Testing of products in contact with drinking water



WaterMark

WM-080042
WMTS-105

CUSTOMER SERVICE

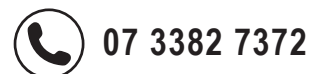

INSTALLATION



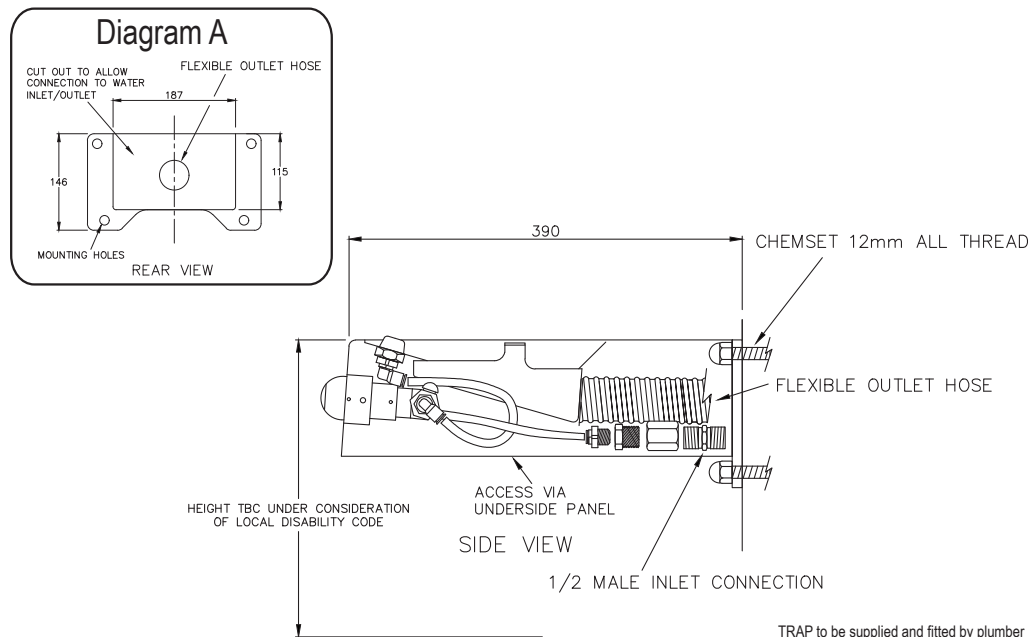





- All UrbanFF Fountains must be installed by a qualified plumber in accordance with National plumbing and drainage code AS/NZS 3500.1 and AS/NZS 3500.2 and any local authority codes.
- Before Installation FLUSH ALL EXTERNAL LINES before connecting to fountain.
PLEASE NOTE: No Trap is supplied inside the fountain. Trap to be fitted externally by plumber.
- When mounting the fountain off a wall, check first with a Structural Engineer to ensure it has the capacity to support this cantilevered fountain. Provide adequate surface for mounting fountain. Mark the mounting points for the fountain and dyna-bolt or chemset in place.
- Allow for waste outlet and water inlet as shown on Diagram A
- Remove the fountain from the packaging preventing scratching and damage.
- All fountains have been checked for leaks as part of our quality assurance program and some droplets of water may be evident inside the packaging and/or unit. This is perfectly normal.
- Remove main access panel from fountain using 4mm allen key.
- Mount the fountain in place and tighten the bolts.
- Connect the 40mm waste outlet pipe to the waste water connection.
- If you have not flushed the external water inlet pipes – do it now! Flushing the water inlet pipes from the mains supply before connecting to fountain will help prevent blockage by any debris that may be in the external pipes.
- Connect water supply to 1/2" BSP inlet.
- Test the bubbler by activating the button.
- Remove underside access panel and adjust the flow rate via the mini ball valve as required so flow enters the middle of the basin (mains water pressure varies from city to city).
- Refer to trouble shooting guide if you experience any problems.
- Check all connections and waste piping to ensure they are tight & secure.
- Re-install access panel once satisfied the fountain is installed correctly.



TROUBLESHOOTING

There is restricted or no water flow?	Check the inlet lines for kinks in the tubing. Ensure the water supply valve is fully open. Check the water pressure regulator is open.
The water continues to drip / run after shutting off?	The most common cause of water not shutting off is a leaking valve and is due to the lines not being flushed adequately and debris getting in to the valve through the inlet and sitting on the rubber seals. To check the valve it will need to be removed. Please contact this office for details instructions to ensure this is done correctly.
The water flow is shooting over the top of the basin or is not high enough and trickling over the nozzle?	The water pressure is too high / low and needs to be adjusted via the water flow regulator so it flows in to the catchment area of the basin.
Leaking from the internal connections?	Check that they have been installed correctly. (all fountains are leak tested prior to leaving the factory). Have the push in fittings been pulled? (see instructions on how to connect and disconnect push in fittings). Is the water inlet connection tight?

SPARE PARTS

 Y fitting	reorder code: 15-JG8-YPIECE	 Self Returning Tap	reorder code: 15-TAP-BUB208C
 1/4 x 90° LF-Fitting	reorder code: 15-LEG8M-ELB-8X1-4	 Maintenance Tap	reorder code: 15-TAP-VP350
 1/4 x 90° Fitting	reorder code: 15-JG8-ELB-1-4X90	 Bottle Filler	reorder code: 15-BUB-TD90P
 3/8 x 90° Fitting	reorder code: 15-JG8-ELB-3-8X90	 Push Button Valve	reorder code: 15-VAL-ENW00415
 1/4 Straight	reorder code: 15-JG8-STR-1-4	 Water Regulator	reorder code: 15-REG-G14
 3/8 Straight	reorder code: 15-JG8-STR-3-8	 Mini Ball Valve	reorder code: 15-VAL-15MINBAL
 1/2 x 90° Fitting	reorder code: 15-JG12-ELB-1-2X90	 Stop tap BUB268	reorder code: 15-VAL-ENW00120
 Blue Hose	reorder code: 15-HOS-BL8	 Bubbler	reorder code: 15-BUB-TD90P