

## CARE AND MAINTENANCE

1. Regular washing down of the exterior surface will help prolong the lustre of the painted finish.
2. Painted fountains that become dull due to prolonged exposure to direct sunlight can be restored with an appropriate surface polish.
3. To maintain the exterior of the fountain carefully remove any loose surface deposits with a wet sponge. Use a soft (non abrasive) brush and dilute a solution of mild detergent (eg. PH-neutral liquid hand washing detergent in warm water (DO NOT use solvents) to remove dust, salt and other deposits. Rinse thoroughly with clean fresh water to remove residues. To remove any Tea Staining on Stainless Steel surfaces we recommend Drifter Hull cleaner and stain remover.
4. Do not use any solvents on the surface as this will adversely affect the longevity of the painted finish.
5. Surface scratches and inconsistencies can be touched up using Dulux touch up paint. Most colours can be matched.
6. We recommend the use of anti-seize paste on all external fixing bolts to maintain ease of access over long periods of time.
7. Check the fountain internal connections, water flow and all external access screws and fixing bolts regularly (every 3mths) to ensure they are tight.
8. In high debris areas (parks, children's playgrounds etc) where there may be sand or bark or a lot of leaf litter that may be placed in to the basin, check regularly and remove debris to prevent blocking of the basin or the waste outlet pipe.
9. After any interruption to the water supply, always flush the lines prior to reconnection to the fountain to prevent debris entering the valve.

## WARRANTY

All Urban Fountains and Furniture outdoor drinking fountains are covered by a 2 year manufacturers guarantee against faulty materials and workmanship under normal wear and tear conditions.

All fountains are date stamped at the time of despatch.

This warranty will only apply under the following conditions:

- The fountain was installed in accordance with our installation instructions that are supplied with every fountain.
- The fountain was installed by a licensed plumber
- The water lines have been thoroughly flushed prior to connection to the fountain
- The fountain has not been tampered with or repaired in any way without obtaining prior approval from our factory specialists first.
- The fountain has been serviced and maintained as per our supplied instructions.

## ATTENTION PLUMBERS

This fountain uses "Push In Fittings". Failure to release these fittings correctly will result in leakage.

These quick release fittings allow instant connection and disconnection without the use of spanners.

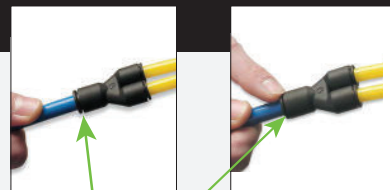

Push outer ring in to release tube from fitting

**urban** + Fountains Furniture

## Drinking Fountains

Models: BF200WM 1, BF200WM 2, BF200WM 3, BF200WM 4

**urban** + Fountains Furniture

## INSTALLATION, OPERATION AND MAINTENANCE INSTRUCTIONS



Model: BF200WM1

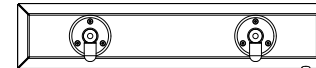

Model: BF200WM2

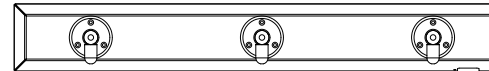

Model: BF200WM3



Model: BF200WM4

## SPECIFICATIONS

- ▶ 1/2" bsb water inlet (15mm)
- ▶ Maximum Temperature: 40°C
- ▶ Maximum Water Pressure: 800 kpa
- ▶ Complies with WMTS-105 Technical Specification: Appliances - Beverage dispensers and icemakers
- ▶ Complies with AS/NZS 4020 Testing of products in contact with drinking water

**2 year**  
warranty

**Lead Free**

WM-080042  
WMTS-105

## CUSTOMER SERVICE



07 3382 7372



office@urbanff.com.au



07 3287 5598



www.urbanff.com.au



## INSTALLATION

- All UrbanFF Fountains must be installed by a qualified plumber in accordance with National plumbing and drainage code AS/NZS 3500.1 and AS/NZS 3500.2 and any local authority codes.
- Before Installation FLUSH ALL EXTERNAL LINES before connecting to fountain.
- When mounting the fountain off a wall, check first with a Structural Engineer to ensure it has the capacity to support this cantilevered fountain. Provide adequate surface for mounting fountain.
- Remove the fountain from the packaging preventing scratching and damage.
- Use a standard Metric Allen Key (size 6) for an M6 CSK head screw. Unscrew 3 x off M6 CSK screws from the front face of the Tap Flange/s. Do this to all instances where there is a tap and flange present, either a 2 tap, 3 tap or 4 tap.
- Pull the sub assembly of the bottle filler tap and flange forward, in order to gain access into the aperture behind the flange plate.
- Present the entire BF200WM bottle filler product, complete with the loose tap and flanges to the wall, or desired location. Using a permanent marking pen, whilst holding the Bottle Filler Product in the desired installation location, mark all mounting holes located on the mounting tabs on the back of the bottle filler, to the wall.
- Remove entire bottle filler product from mounting location and using an 8mm masonry drill, drill holes into wall to desired depth. \* Please note, this is a recommendation, mechanical fasteners may differ by installation specialist decision.
- Insert M8 x 75 (or similar) dyna bolts into drilled hole location in the wall.
- Present complete BF200WM bottle filler product, complete with loose taps and flanges, to the wall and fix to inserted dynabolt positions.
- Whilst Bottle filler product is in position on the wall, using a socket wrench with an extension and desired socket size, present M8 nuts to the M8 dyna bolts and screw up tight. This must be done through the front facing aperture behind the tap and mount flange, from the front of the bottle filler product.
- Feed the filler tap and flange back into the aperture on the front of the fountain and use the size 6 Allen key to screw the flanges back into their original position on the front of the fountain.
- A certified Plumber must connect the main water supply to the fountain by screwing a standard 1/2 inch connection to the provided inlet location on the bottom right-hand side of the bottle filler product.
- Please see below the associated diagrams.

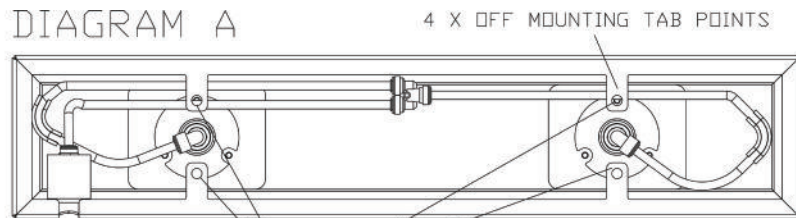

Ø10MM HOLE FOR M8 DYNO BOLTS  
4 X OFF POSITIONS

RECOMMENDED 4 X OFF  
M8 X 75MM DYNO BOLTS

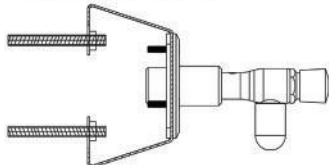

## TROUBLESHOOTING

<b>There is restricted or no water flow?</b>	Check the inlet lines for kinks in the tubing. Ensure the water supply valve is fully open. Check the water pressure regulator is open.
<b>The water continues to drip / run after shutting off?</b>	The most common cause of water not shutting off is a leaking valve and is due to the lines not being flushed adequately and debris getting in to the valve through the inlet and sitting on the rubber seals. To check the valve it will need to be removed. Please contact this office for details instructions to ensure this is done correctly.
<b>The water flow is shooting over the top of the basin or is not high enough and trickling over the nozzle?</b>	The water pressure is too high / low and needs to be adjusted via the water flow regulator so it flows in to the catchment area of the basin.
<b>Leaking from the internal connections?</b>	Check that they have been installed correctly. (all fountains are leak tested prior to leaving the factory). Have the push in fittings been pulled? (see instructions on how to connect and disconnect push in fittings). Is the water inlet connection tight?

## SPARE PARTS

8mm "Y" Fitting	reorder code: PL1003	Maintenance Tap	reorder code: PL1034
1/4" Legris Fitting	reorder code: PL1030	Bottle Filler	reorder code: CM1125
1/4 x 90° Fitting	reorder code: ELB 1/4" x 90	Urban Push tap with Paw print	reorder code: CM1125-DT
3/8 x 90° Fitting	reorder code: ELB 3/8" x 90	Enware Valve	reorder code: DFX.A280.VALVE.ASSY
8mm Straight Male -1/4" BSPT	reorder code: PL1011	Urban "T" Valve	reorder code: CM1110
8mm Straight Male -3/8" BSPT	reorder code: PL1035	Pressure Control Valve	reorder code: PL1114
5/16" Hose-Blue	reorder code: PL1108	15mm Mini Ball Valve	reorder code: PL1019
Self Returning Tap	reorder code: PL1008	Stop tap BUB268	reorder code: PL1031
8mm Stem-1/4" BSPT	reorder code: PL1000	Urban Bubbler	reorder code: CM1125-MG
8mm Stem-3/8" BSPT	reorder code: PL1001	8mm Equal Elbow	reorder code: PL1002
1/2" Hollow Brass All Thread	reorder code: PL1007		

**urban** + Furniture

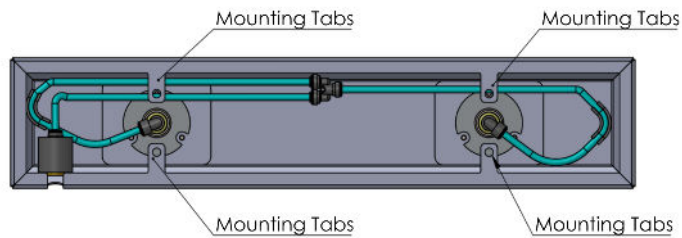
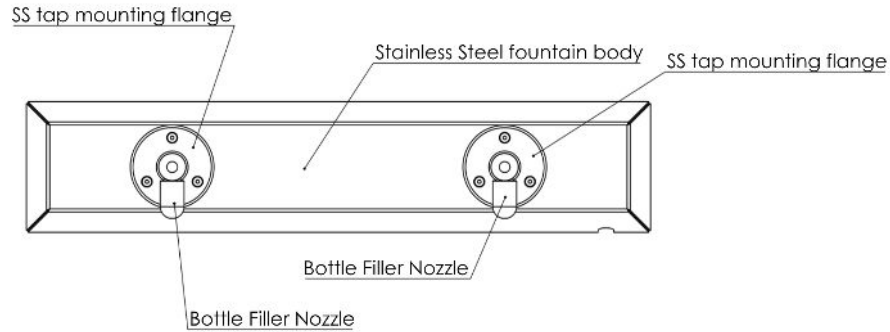

# Dimensions & Mounting Locations

